



MAGNAVOX

CD BOOMBOX

with AM/FM Radio



OWNER'S MANUAL

PLEASE READ BEFORE OPERATING THIS EQUIPMENT.

MODEL: MD6923

Size: 148.5(W) x 210(H)mm (A5)

IMPORTANT SAFETY INSTRUCTION

	CAUTION RISK OF ELECTRIC SHOCK DO NOT OPEN	
CAUTION: TO REDUCE THE RISK OF ELECTRIC SHOCK, DO NOT REMOVE COVER (OR BACK). NO USER-SERVICEABLE PARTS INSIDE. REFER SERVICING TO QUALIFIED SERVICE PERSONNEL.		



DANGEROUS VOLTAGE:

The lightning flash with arrowhead symbol, within an equilateral triangle is intended to alert the user to the presence of uninsulated dangerous voltage within the product's enclosure that may be of sufficient magnitude to constitute a risk of electric shock to persons.



ATTENTION:

The exclamation point within an equilateral triangle is intended to alert the user to the presence of important operating and maintenance (servicing) instructions in the literature accompanying the appliance.

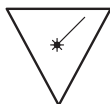

DANGER

Invisible and hazardous laser radiation when open and inter-lock failed or defeated. Avoid direct exposure to beam.

FCC WARNING:

This equipment may generate or use radio frequency energy. Changes or modifications to this equipment may cause harmful interference unless the modifications are expressly approved in the instruction manual. Modifications not authorized by the manufacturer may void users authority to operate this device.

WARNING:

TO REDUCE THE RISK OF FIRE OR ELECTRIC SHOCK, DO NOT EXPOSE THIS PRODUCT TO RAIN OR MOISTURE.
TO REDUCE THE RISK OF FIRE OR ELECTRIC SHOCK, AND ANNOYING INTERFERENCE, USE THE RECOMMENDED ACCESSORIES ONLY.

LASER SAFETY : This unit employs a laser. Only qualified service personnel should attempt to service this device due to possible eye injury.

CAUTION : USE OF CONTROLS, ADJUSTMENTS OR PERFORMANCE PROCEDURE HERENIN MAY RESULT IN HAZARDOUS RADIATION EXPOSURE.

INFORMATION:

This equipment has been tested and found to comply with the limits for a Class B digital device, pursuant to Part 15 of the FCC Rules. These limits are designed to provide reasonable protection against harmful interference in a residential installation. This equipment generates, uses and can radiate radio frequency energy and, if not installed and used in accordance with the instructions, may cause harmful interference to radio communications. However, there is no guarantee that interference will not occur in a particular installation. If this equipment does cause harmful interference to radio or television reception, which can be determined by turning the equipment off and on, the user is encouraged to try to correct the interference by one or more of the following measures:

- Reorient or relocate the receiving antenna.
- Increase the separation between the equipment and receiver.
- Connect the equipment into an outlet on a circuit different from that to which the receiver is connected.
- Consult the dealer or an experienced radio/TV technician for help.

IMPORTANT SAFETY INSTRUCTION

Before using the unit, be sure to read all operating instructions carefully. Please note that these are general precautions and may not pertain to your unit. For example, this unit may not have the capability to be connected to an outdoor antenna.

1) Read these instructions.

All the safety and operating instructions should be read before the product is operated.

2) Keep these instructions.

The safety and operating instructions should be retained for future reference.

3) Heed all warnings.

All warnings on the product and in the operating instructions should be adhered to.

4) Follow all instructions.

All operating and use instructions should be followed.

5) Do not use this apparatus near water.

Do not use this product near water and moisture, for example: near a bathtub, washbowl, kitchen sink or laundry tub; in a wet basement; or near a swimming pool.

6) Clean only with dry cloth.

Unplug this product from the wall outlet before cleaning. Do not use liquid cleaners or aerosol cleaners. Use a dry cloth for cleaning.

7) Do not block any ventilation openings. Install in accordance with the manufacturer's instructions.

Slots and openings in the cabinet and in the back or bottom are provided for ventilation, to ensure reliable operation of the product and to protect it from overheating. These openings must not be blocked or covered. The openings should never be blocked by placing the product on a bed, sofa, rug or other similar surface. This product should never be placed near or over a radiator or heat source. This product should not be placed in a built-in installation such as a bookcase or rack unless proper ventilation is provided or the manufacturer's instructions have been adhered to.

8) Do not install near any heat sources such as radiators, heat registers, stoves, or other apparatus (including amplifiers) that produce heat.

9) Do not defeat the safety purpose of the polarized or grounding-type plug.

A polarized plug has two blades with one wider than the other. A grounding type plug has two blades and a third grounding prong. The wide blade or the third prong is provided for your safety. If the provided plug does not fit into your outlet, consult an electrician for replacement of the obsolete outlet.

10) Protect the power cord from being walked on or pinched particularly at plugs, convenience receptacles, and the point where they exit from the apparatus.

11) Only use attachments/accessories specified by the manufacturer.

12) Use only with the cart, stand, tripod, bracket, or table specified by the manufacturer, or sold with the apparatus. When a cart is used, use caution when moving the cart/apparatus combination to avoid injury from tip-over.

An appliance and cart combination should be moved with care.

Quick stops, excessive force and uneven surfaces may cause the appliance and cart combination to overturn.



IMPORTANT SAFETY INSTRUCTION

13) Unplug this apparatus during lightning storms or when unused for long periods of time.

To protect your product from a lightning storm, or when it is left unattended and unused for long periods of time, unplug it from the wall outlet and disconnect the antenna or cable system. This will prevent damage to the product due to lightning and power-line surges.

14) Refer all servicing to qualified service personnel. Servicing is required when the apparatus has been damaged in any way, such as power-supply cord or plug is damaged, liquid has been spilled or objects have fallen into the apparatus, the apparatus has been exposed to rain or moisture does not operate normally, or has been dropped.

15) Power source

This product should be operated only from the type of power source indicated on the marking label. If you are not sure of the type of power supply to your home, consult your appliance dealer or local power company. For products intended to operate from battery power, or other source, refer to the operation instructions.

16) Power lines

An outside antenna system should not be located in the vicinity of overhead power lines or other electric light or power circuits, or where it can fall into such power lines or circuits. When installing an outside antenna system, extreme care should be taken to keep from touching such power lines or circuits as contact with them might be fatal.

17) Overloading

Do not overload wall outlets and extension cords as this can result in a risk of fire or electric shock.

18) Object and liquid entry

Never push objects of any kind into this product through openings as they may touch dangerous voltage points or short out parts that could result in fire or electric shock. Never spill or spray any type of liquid on the product.

19) Outdoor antenna grounding

If an outside antenna is connected to the product, be sure the antenna system is grounded so as to provide some protection against voltage surges and built up static charges. Section 810 of the National Electric Code ANSI/NFPA 70 provides information with respect to proper to grounding of the mast and supporting structure, grounding of the lead-in wire to an antenna discharge product, size of grounding conductors, location of antenna-discharge product, connection to grounding electrodes and requirements for the grounding electrodes.

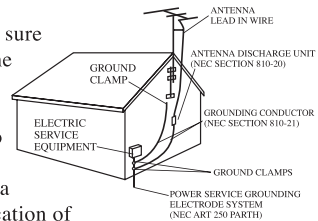

20) Service

Do not attempt to service this product yourself as opening or removing covers may expose you to dangerous voltage or other hazards. Refer all servicing to qualified service personnel.

IMPORTANT SAFETY INSTRUCTION

21) Replacement parts

When replacement parts are required, be sure the service technician uses replacement parts specified by the manufacturer or those that have the same characteristics as the original parts. Unauthorized substitutions may result in fire or electric shock or other hazards.

22) Safety check

Upon completion of any service or repairs to this product, ask the service technician to perform safety checks to determine that the product is in proper operation condition.

23) Wall or ceiling mounting

The product should be mounted to a wall or ceiling only as recommended by the manufacturer.

24) Damage requiring service

Unplug this product from the wall outlet and refer service to qualified service personnel under the following conditions.

- a) When the power-supply cord or plug is damaged.
- b) If liquid has been spilled or objects have fallen into the product.
- c) If the product has been exposed to rain or water.
- d) If the product does not operate normally by following the operating instructions. Adjust only those controls that are covered by the operating instructions, as an adjustment of other controls may result in damage and will and require extensive work by a qualified technician to restore in the product to its normal operation.
- e) If the product has been dropped or the cabinet has been damaged.
- f) When the product exhibits a distinct change in performance-this indicates a need for service.

25) Note to CATV system installer

This reminder is provided to call the CATV system installer's attention to Article 820-40 of the NEC that provides guidelines for proper grounding and, in particular, specifies that the cable ground shall be connected to the grounding system of the building, as close to the point of cable entry as practical.

NOTE: Refer all servicing to qualified service personnel. Servicing is required when the unit has been damaged in any way such as the following: the power-supply cord or plug has been damaged, liquid has been spilled into the unit, the unit has been exposed to rain or moisture, the unit has been dropped or the unit does not operate normally.

PREPARATION FOR USE

POWER SOURCES

This portable audio system is designed to operate on either AC 120V~, 60Hz house current or by six (6)"C" size batteries (not included). Attempting to operate this unit from any other power source may cause damage to the unit, which is not covered by your warranty.

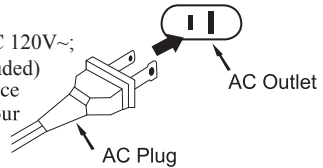

AC OPERATION

Unwind the AC cord and extend it to its full length. Insert the small end of the AC cord into the AC socket on the rear of the unit. Insert the other end of the AC cord into any convenient AC 120V~, 60Hz household outlet.

Please note that this unit is equipped with a polarized AC plug which has one blade wider than the other. This is a safety feature to reduce the likelihood of electric shock. This polarized AC plug will only fit in a polarized AC outlet. If you find that you cannot insert this plug into your outlet, you may have an obsolete non-polarized outlet. Please do not try to defeat this safety feature by using a non-polarized adapter or by filling the wider blade to make it fit into your outlet. If this plug does not fit into your outlet, you should contact a qualified licensed electrician to replace your obsolete outlet.

NOTE: When AC Cord is connected to the unit, the batteries power will be cut off automatically.

BATTERY INSTALLATION

To use this unit with battery power, remove the battery door by pressing in on the tabs, then lifting it off. Insert six (6) "C" size batteries (not included) following the diagram in the compartment.

NOTE: The AC power cord must be disconnected from the AC socket on the rear of the unit in order for the unit to operate on battery power.

BATTERY PRECAUTIONS

Follow these precautions when using a battery in this device:

1. Use only the size and type of battery specified.
2. Be sure to follow the correct polarity when installing the battery as indicated in the battery compartment. A reversed battery may cause damage to the device.
3. Do not mix different types of batteries together (e.g. Alkaline and Carbon-zinc) or old batteries with fresh ones.
4. If the device is not to be used for a long period of time, remove the battery to prevent damage or injury from possible battery leakage.
5. Do not try to recharge the battery not intended to be recharged; it can overheat and rupture. (Follow battery manufacturer's directions.)
6. Do not dispose of batteries in fire. Battery may explode or leak.
7. Clean the battery contacts and also those of the device prior to battery installation.

CARE AND MAINTENANCE

Caring for Compact Discs

- Treat the disc carefully. Handle the disc only by its edges. Never allow your fingers to come in contact with the shiny, unprinted side of the compact disc.
- Do not attach adhesive tape, stickers, etc. to the compact disc label.
- Clean the compact disc periodically with a soft, lint-free, dry cloth. Never use detergents or abrasive cleaners to clean the compact disc. If necessary, use a CD cleaning kit.
- If a compact disc skips or gets stuck on a section of the compact disc, it is probably dirty or damaged (scratched).
- When cleaning the compact disc, wipe in straight lines from the centre of the compact disc to the outer edge of the compact disc. Never wipe in circular motions.

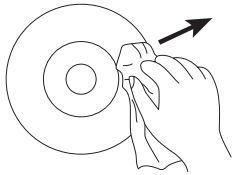
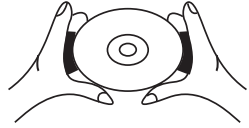

- This unit is designed to play only compact discs bearing the identification logo as shown here. Other discs may not conform to the CD standard and may not play properly.
- Compact Discs should be stored in their cases after each use to avoid damage.
- Do not expose compact discs to direct sunlight, high humidity, high temperatures or dust, etc. Prolonged exposure or extreme temperatures can warp the disc.
- Do not stick or write anything on either side of the disc. Sharp writing instruments, or the ink, may damage the surface.



Cleaning the Unit

- To prevent fire or shock hazard, disconnect your unit from the AC power source when cleaning.
- The finish on your unit may be cleaned with a dust cloth and cared for as other furniture. Use caution when cleaning and wiping the plastic parts.
- Mild soap and a damp cloth may be used on the front panel.

LOCATION OF CONTROLS

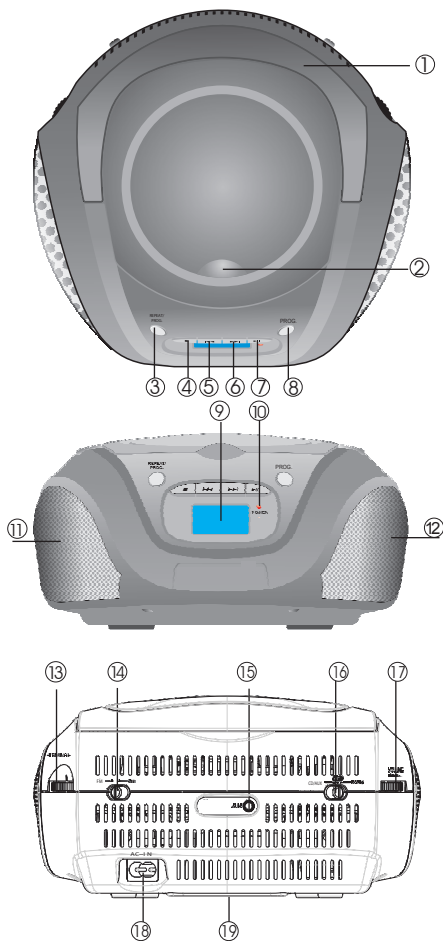

1. Handle
2. CD door
3. REPEAT/RAND (Repeat/Random) button
4. ■ Stop button
5. ◀◀ button
6. ▶▶ button
7. ▶| button
8. PROG. (Program) button
9. LCD display
10. POWER (Power on) indicator
11. Left speaker
12. Right speaker
13. TUNING knob
14. FM-AM band switch
15. AUX (in) jack
16. Function selector
17. VOLUME knob
18. AC~IN socket
19. Battery compartment (bottom side)

OPERATION

Radio:

1. Slide the Function selector to RADIO position to turn on the radio.
2. Slide the AM-FM band switch to AM or FM as desire.
3. Turn the TUNING knob to receiving the desired radio station.
4. Turn the VOLUME knob to adjust volume level as desire.
5. When finished listening, slide the Function selector to OFF position to power off the unit.

Antennas:

This unit has a built in AM and FM antennas, which provides adequate reception in most areas. If reception is weak, turn or relocate the unit to improve reception.

CD:

1. Slide the Function selector to CD/AUX position to turn on the CD.
2. Open the CD door then place a CD disc on the center spindle, with the printed side face up.
3. Close the CD door and wait a few seconds. The number of the total tracks will appear on the display.
4. Press the **▶** (Play/Pause) button to start playback the first track on the disc. Indicator "PLAY" will appear on the display.
5. During playback:
 - A. Turn the VOLUME knob to adjust volume level as desire.
 - B. Press the **▶** (Play/Pause) button to pause (Indicator "PLAY" on the display will blink); press again to resume normal playback (Indicator "PLAY" on the display will stop blinking).
 - C. Press the **◀** or **▶** buttons repeatedly to skip the tracks.
 - D. Press and hold the **◀** or **▶** buttons to fast searching the specific section then release it to resume normal playback.
6. To stop CD playback, press the **■** (Stop) button. The total number of tracks will appear on the display.
7. When finished listening, slide the Function selector to OFF position to power off the unit.

Repeat/Random Playback:

1. During playback, press the REPEAT/RAND (Repeat/Random) button once. The repeat one indicator **↺** will appear on the display. The current track will playback repeatedly.
2. During playback, press the REPEAT/RAND button twice. The repeat all indicator **↻** will appear on the display. All the tracks on the current disc (or program) will be playback repeatedly.
3. During playback, press the REPEAT/RAND button three times, the indicator "RAND" (Random) will appear on the display. The unit will plays the tracks randomly.
4. To cancel the repeat and random play functions, press the **■** (Stop) to stop playback.

Programmed Playback:

Up to 20 tracks can be programmed playback as follows:

1. In CD STOP mode, press the PROG. (Program) button. "P 1 --" will appear on the display and blinking.
2. Select the first specific track to be programmed by pressing the **◀** or **▶** buttons repeatedly..
3. Press the PROG. (Program) button to store the selected track into the memory.
4. Repeat steps 2 and 3 until all the specific tracks stored into the memory.
5. Press the **▶** Play/Pause button to start playback. The program indicator "P PLAY" will appear on the

display.

6. To stop playback, press the ■ (Stop) button.
7. To cancel the program, press the ■ (Stop) button again in stop mode. The program indicator will disappear on the display.

Note: Random play is not available in Program playback mode.

AUX (in):

1. Slide the Function selector to CD/AUX position to power on the unit.
2. Connect the external audio device with a 3.5mm AUX cable (AUX cable not included).
3. Insert one end to the Phone; Line Out or AUX Out jack on the external audio device.
4. Insert the other end to the AUX (in) jack on the rear of unit Indicator "AUX" will appear on the display.

Note: In this mode, the CD Player will not function. Unplug the cable from the unit before using CD Player.

5. Play the music on the connected external audio device as usual.
6. Turn the VOLUME knob to adjust volume level as desired.
7. When no longer in use, slide the Function selector to OFF position to power off the unit.

NOTES:

- Make sure the sound output level of the connected external audio device in high level. Otherwise, sound will weak.
- If sound is distorting, reduce the volume of the connected external audio device or set the EQ mode of it to normal.

CONDENSATION

If cold water is poured into a glass, water droplets on the outside of the glass. This is called condensation. Condensation may also occur on internal operating parts of the laser pickup. Condensation occurs:

- When the unit is brought from the outdoors into a warm room, or if it is in a cold room which is heated quickly.
- In the summer, if the unit is moved suddenly from an air-conditioned room or car to a hot or humid location.
- Should condensation occur, the product may not operate properly. When the product is exposed to temperature extremes, wait for 1-2 hours(to allow the internal parts to adjust to the surrounding temperature) before use.

TROUBLESHOOTING GUIDE

SYMPTOM	POSSIBLE CAUSE	POSSIBLE SOLUTION
GENERAL		
Power does not come on.	AC line cord not plugged in.	Plug in the AC cord.
	Batteries are not correctly installed.	Install the batteries as the batteries polarity marks inside the battery compartment.
	Batteries are weak or dead.	Replace the old batteries by new batteries.
RADIO		
No sound.	Function selector is set to OFF position.	Set Function selector to CD/AUX or RADIO
	VOLUME control at minimum position.	Turn the VOLUME knob clockwise to increase sound level.
Noise or sound distorted on AM or FM.	Location or direction no good for radio reception.	Relocation or turn the unit to a new location or direction for better radio reception.
CD Player		
CD Skips	Disc not good or badly scratched.	Try others disc.
CD will not play	Function selector is not in CD/AUX position.	Slide Function selector to CD/AUX position.
	Disc is inserted incorrectly.	Reinsert disc ensuring center is securely attached to spindle, with the printed side face up.
	CD compartment door is not closed.	Close CD door completely.

SPECIFICATIONS

GENERAL

Power Source AC 120V~; 60Hz, 10W DC ---9V (6 x "C" size batteries, not included)

AUDIO

Output Power..... 800 mW×2
 Frequency Range (AM)..... 530 – 1710 kHz
 Frequency Range (FM)..... 87.5–108 MHz
 Speaker Impedance..... 8 Ohms; 3W x 2

ACCESSORIES:

1 x AC Power Cord
 1 x User's Manual

SPECIFICATIONS AND ACCESSORIES ARE SUBJECT TO CHANGE WITHOUT NOTICE

LIMITED WARRANTY

Craig Electronics warrants this product to be free from manufacturing defects in material and workmanship under normal use for a period of 180 days from date of purchase. If service is required, please return the product to the store where it was purchased for exchange; or, pack the unit in the original packing material with all accessories if applicable, a copy of your sales receipt and a Cashier's check or Money Order for \$7 (to cover shipping and handling costs) payable to Craig Electronics Inc. For consumers in Canada, please make sure that the cashier check or money order is redeemable through a U.S. bank. Ship your product freight pre-paid. Your unit will be repaired, replaced or if the unit can not be repaired or replaced, a refund will be forwarded to you within four weeks of receipt of your unit. Please ship your unit to:

Craig Electronics Inc.
1160 NW 163 Drive
Miami, FL 33169

This warranty is void if the product has been: a) Used in a commercial application or rental. b) Damaged through misuse, negligence, or abuse. c) Modified or repaired by anyone other than an authorized Craig service center. d) Damaged because it is improperly connected to any other equipment.

Note: This warranty does not cover: a) Ordinary adjustments as outlined in the Owner's Manual which can be performed by the customer. b) Damage to equipment not properly connected to the product. c) Any cost incurred in shipping the product for repair. d) Damage to the product not used in the USA.

This warranty is not transferable and only applies to the original purchase. Any implied warranties, including the warranty of merchantability, are limited in duration to the period of this expressed warranty and no warranty whether expressed or implied shall apply to the product thereafter.

Under no circumstance shall Craig be liable for any loss or consequential damage arising out of the use of this product. This warranty gives specific legal rights. However, you may have other rights which may vary from state to state. Some states do not allow limitations on implied warranties or exclusion of consequential damage. Therefore, these restrictions may not apply to you.

This product has been manufactured by and is sold under the responsibility of Craig Electronics Inc, and Craig Electronics Inc is the warrantor in relation to this product. MAGNAVOX and SMART. VERY SMART are registered trademarks of Koninklijke Philips N.V. and are used under license from Koninklijke Philips N.V.

To Obtain Service on your Product
email: service@craigelectronics.com